

# Specification

1. Product Type: 5G Antenna

2. Part No: 201-940

3. Frequency : 600~6000 MHZ

4. VSWR: 2.0:1

5. Cable: RG316U

6. Connector: SMA-Han

✳️RoHS Compliant

**NB! annen konnektor enn tegning.  
Leveres med SMA-Han rett**

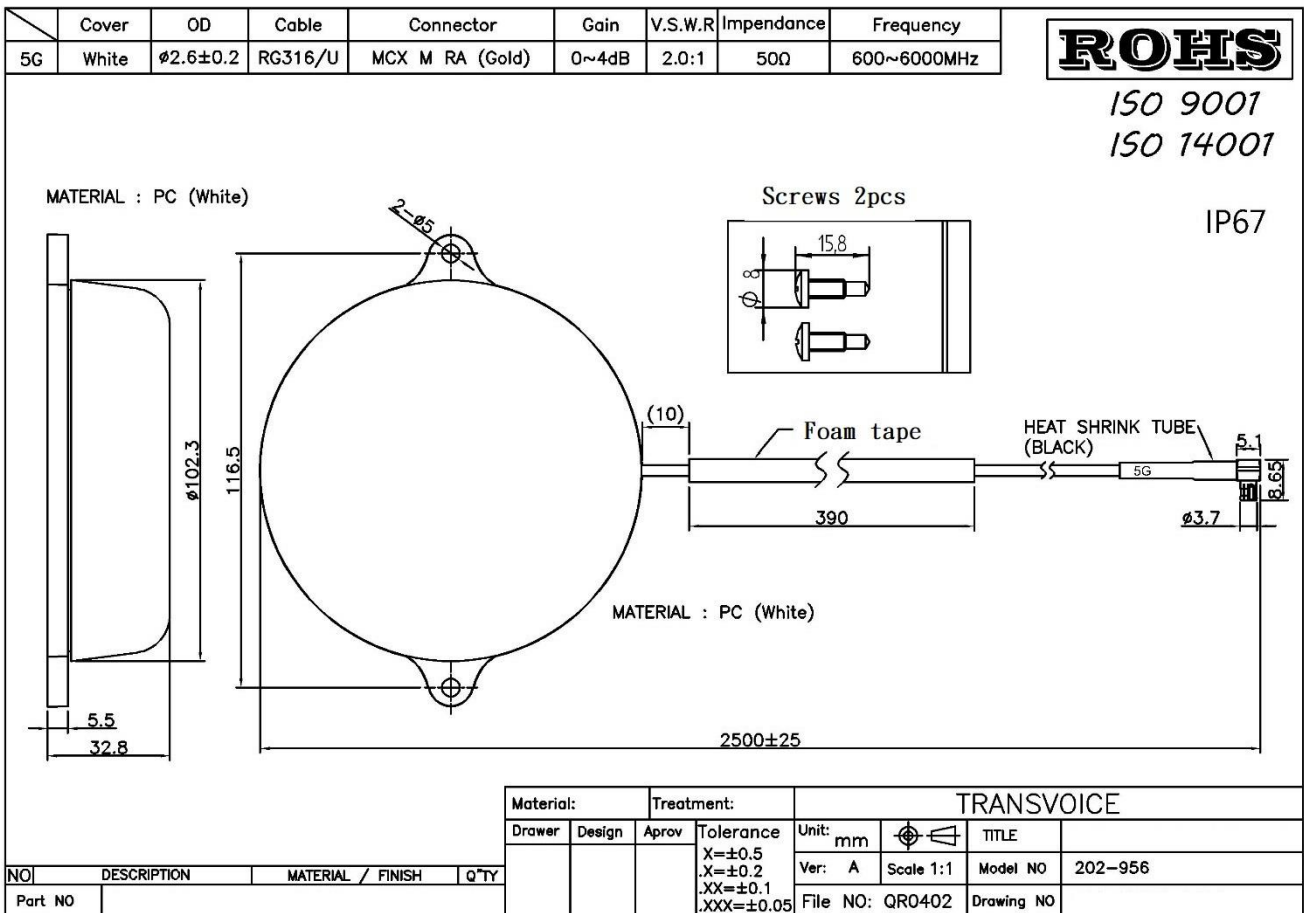

Frequency (MHz)	Return Loss (dB)	VSWR	Efficiency (%)	Gain (dBi)
600	-8.03	2.30	30.9	-1.17
690	-10.12	1.88	26.85	-0.84
824	-9.86	1.96	49.09	1.08
960	-11.59	1.70	72.28	3.27
1710	-16.76	1.34	41.98	1.9
1880	-13.13	1.58	25.06	-0.11
2170	-8.43	2.28	29.51	1.76
2400	-10.61	1.84	48.42	5.72
2500	-13.24	1.61	34.51	4.69
2600	-11.03	1.80	31.19	4.57
2700	-14.24	1.48	38.99	5.38
3300	-8.05	2.31	34.28	3.71
3600	-11.62	1.71	61.09	5.16
3800	-12.99	1.58	69.18	6.16
4400	-14.80	1.57	43.85	6.39
5150	-15.16	1.45	43.65	6.18
5500	-14.93	1.43	44.67	3.83
5800	-10.94	1.84	37.76	4.25

# Test Report (Return Loss & VSWR)

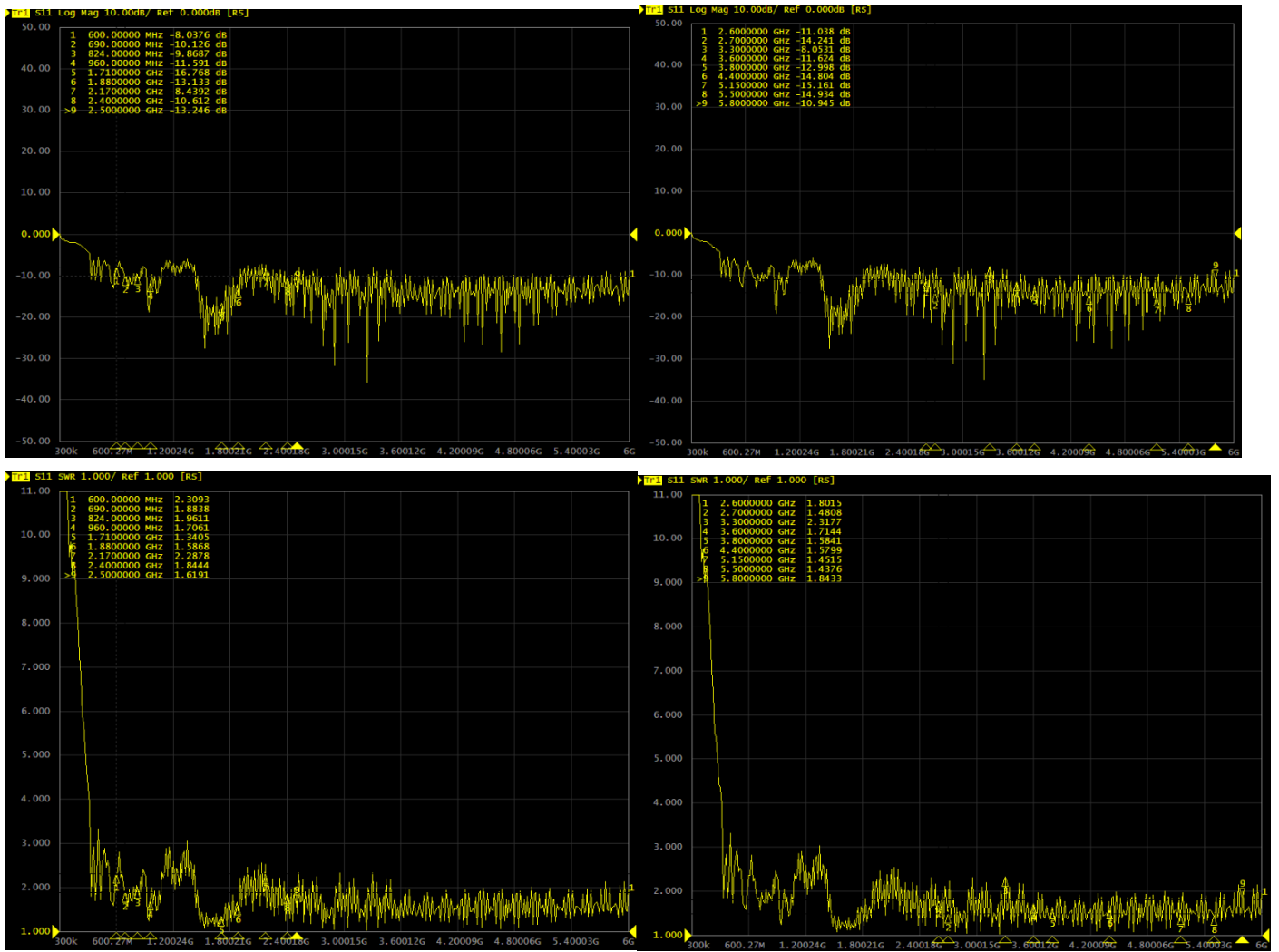

## 3D Test photo



# 3D Test Data

Freq. / Chan.	Color
600MHz	Red
690MHz	Blue
824MHz	Green
960MHz	Yellow
1.71GHz	Black
1.88GHz	Purple
2.17GHz	Dark Blue
2.4GHz	Teal
2.5GHz	Orange
2.6GHz	Light Blue
2.7GHz	Dark Green
3.3GHz	Magenta
3.6GHz	Tan
3.8GHz	Brown
4.4GHz	Dark Blue
5.15GHz	Grey
5.5GHz	Light Green
5.8GHz	Orange

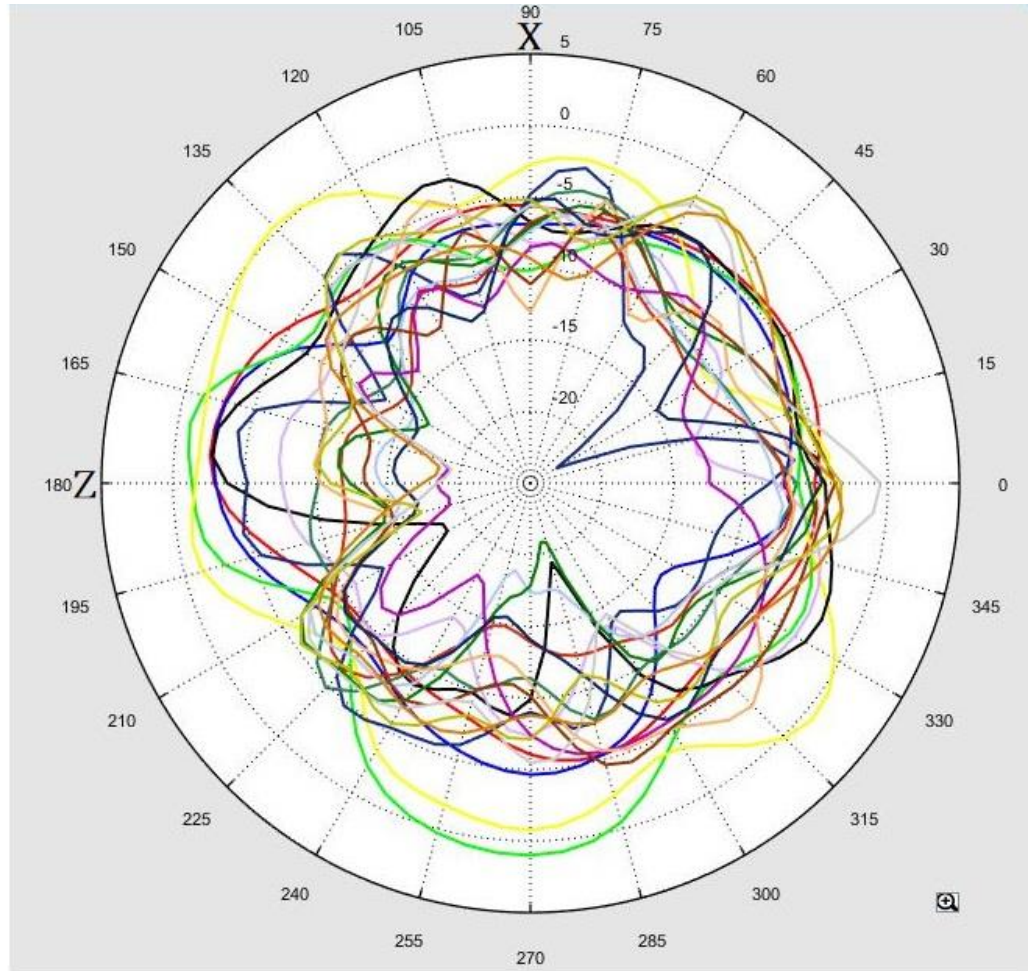

Total\_Efficiency (%)

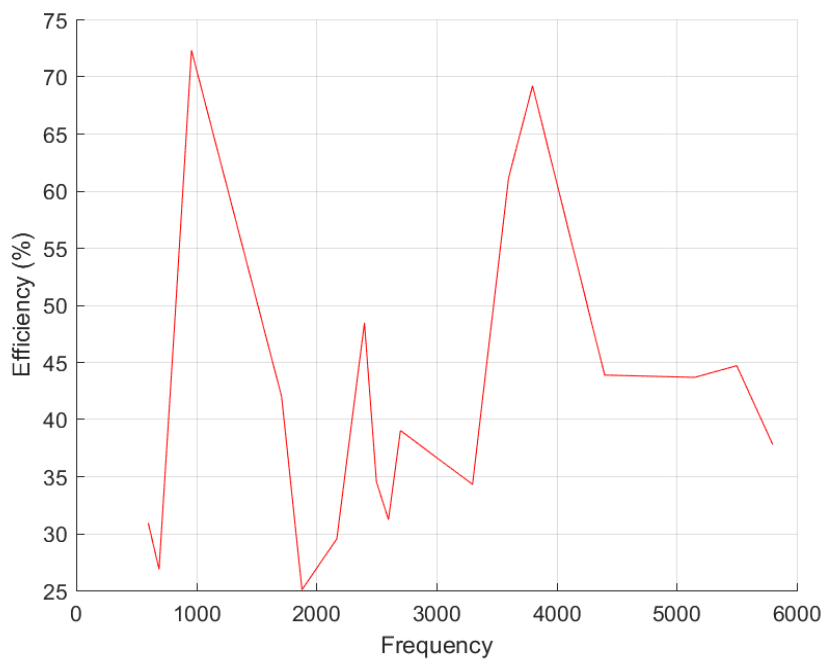

# Total\_Gain (dBi)

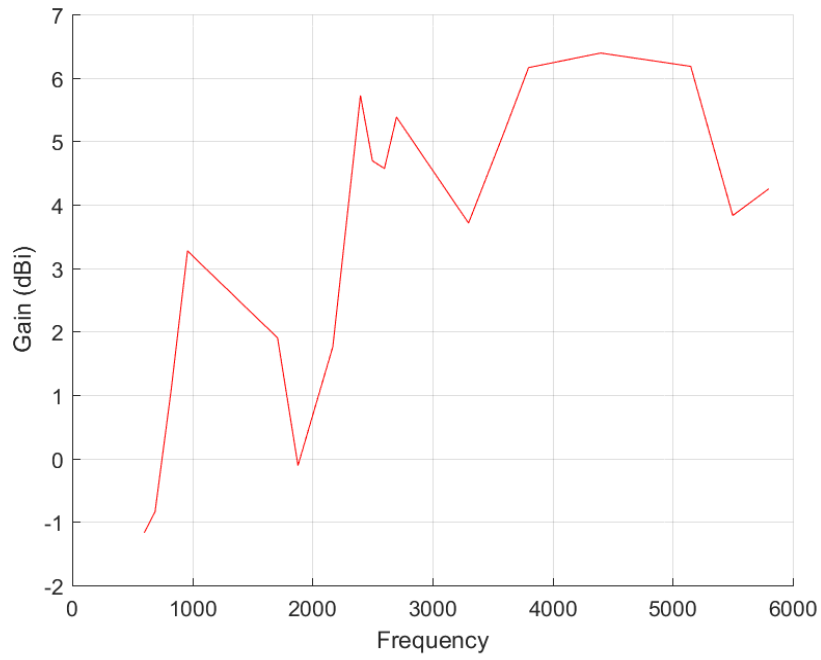

Total\_3D\_Top View\_600MHz

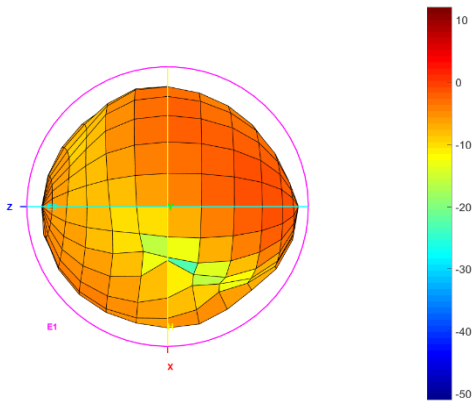

Total\_3D\_Front View\_600MHz

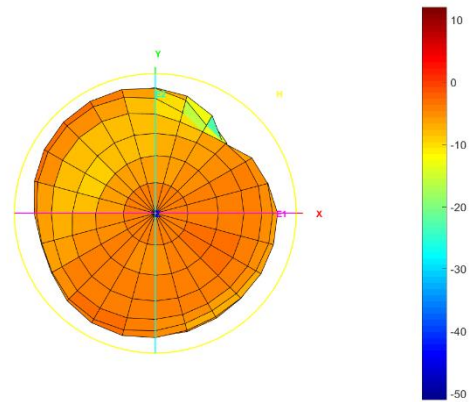

Total\_3D\_Left View\_600MHz

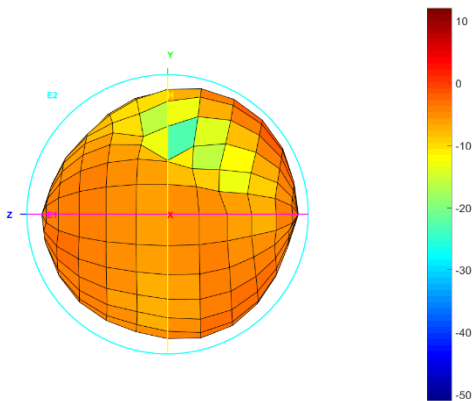

Total\_3D\_Side View 1\_600MHz

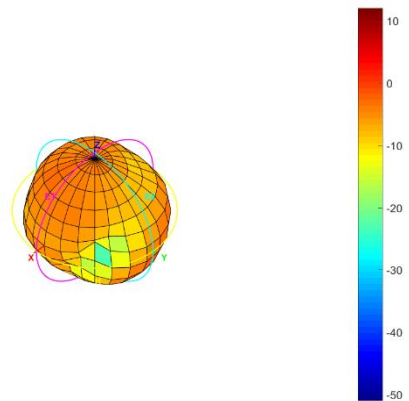

Total\_3D\_Top View\_690MHz

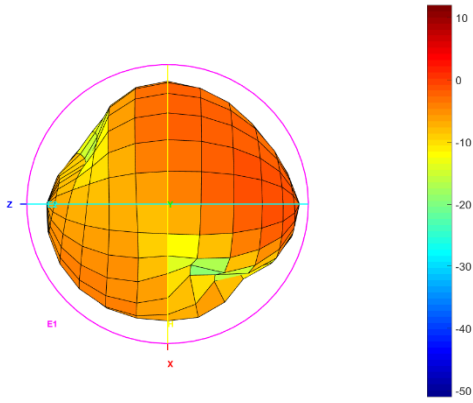

Total\_3D\_Front View\_690MHz

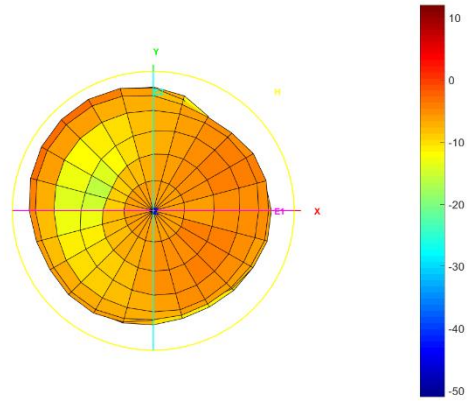

Total\_3D\_Left View\_690MHz

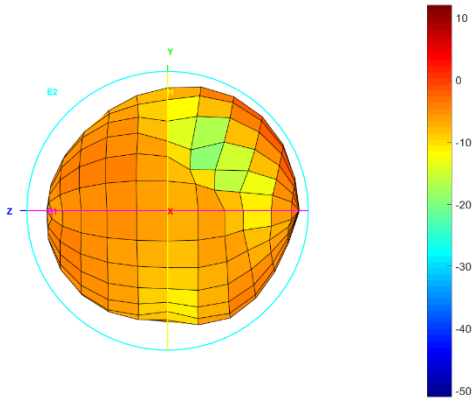

Total\_3D\_Side View 1\_690MHz

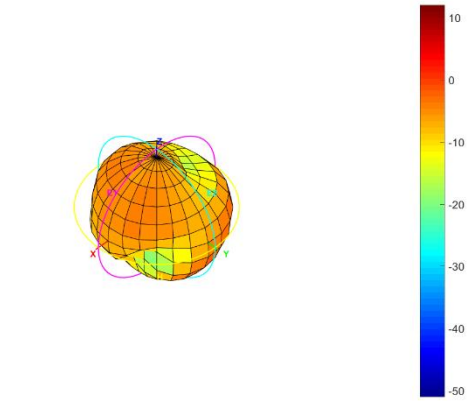

Total\_3D\_Top View\_824MHz

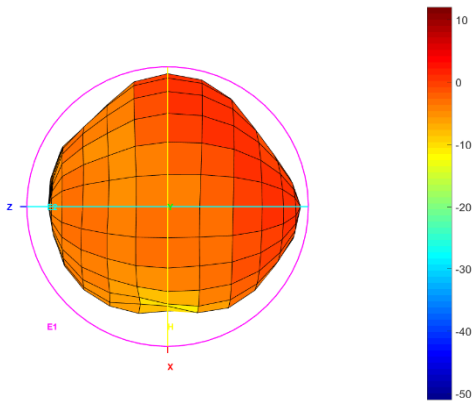

Total\_3D\_Front View\_824MHz

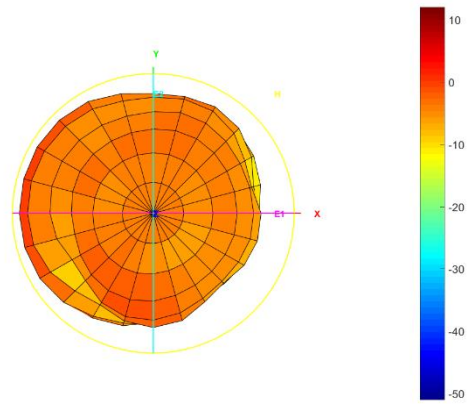

Total\_3D\_Left View\_824MHz

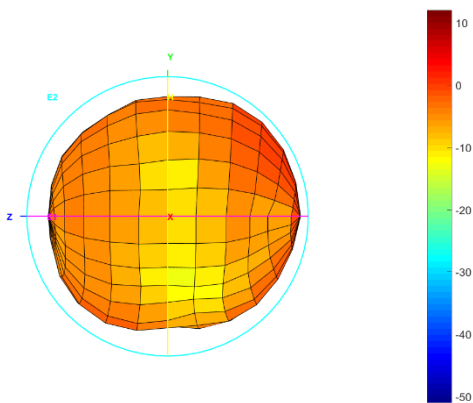

Total\_3D\_Side View 1\_824MHz

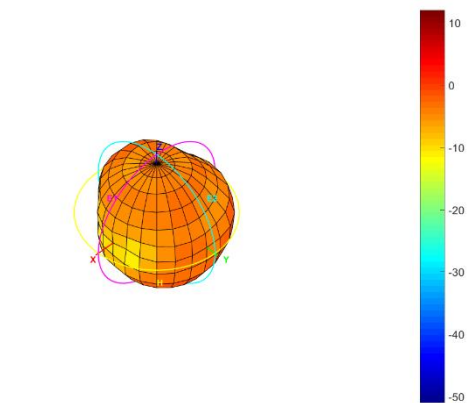

Total\_3D\_Top View\_960MHz

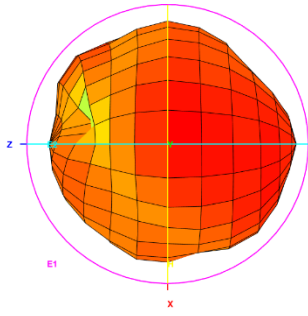

Total\_3D\_Front View\_960MHz

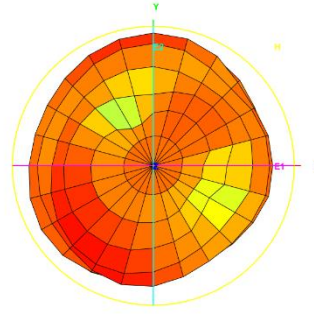

Total\_3D\_Left View\_960MHz

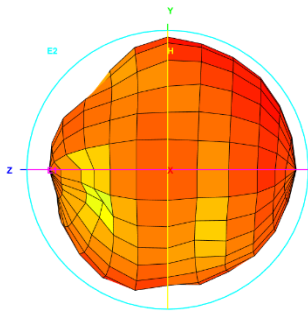

Total\_3D\_Side View\_1\_960MHz

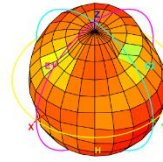

Total\_3D\_Top View\_1.71GHz

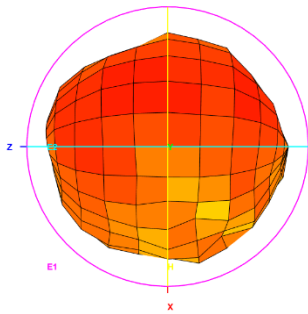

Total\_3D\_Front View\_1.71GHz

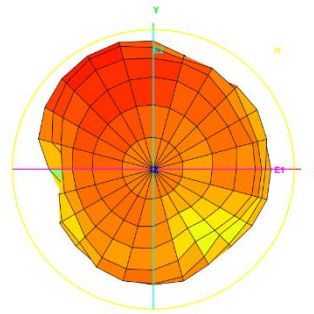

Total\_3D\_Left View\_1.71GHz

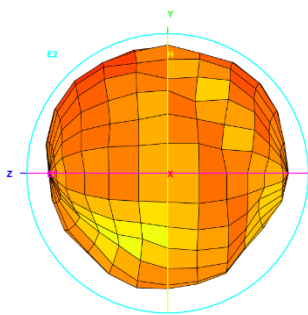

Total\_3D\_Side View\_1\_1.71GHz

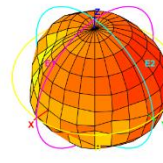

Total\_3D\_Top View\_1.88GHz

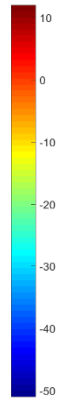
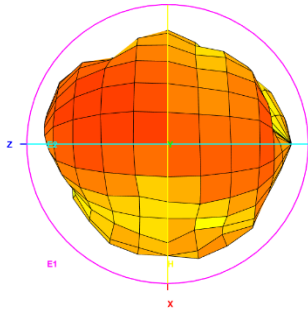

Total\_3D\_Front View\_1.88GHz

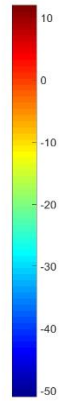
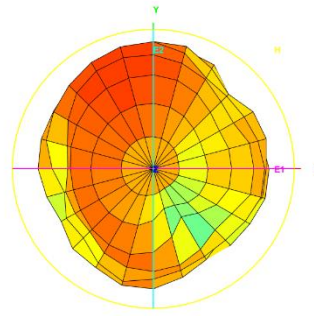

Total\_3D\_Left View\_1.88GHz

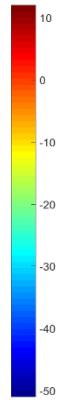
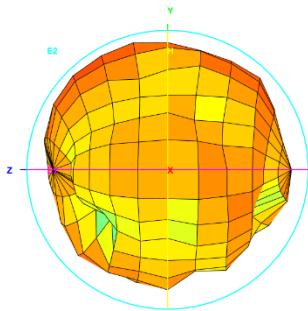

Total\_3D\_Side View 1\_1.88GHz

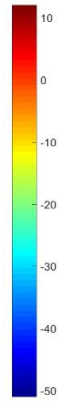
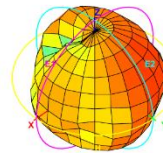

Total\_3D\_Top View\_2.17GHz

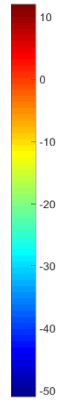
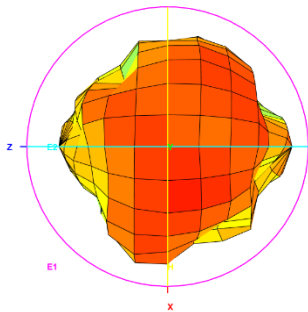

Total\_3D\_Front View\_2.17GHz

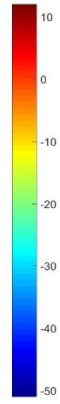
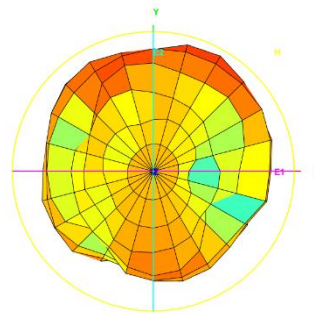

Total\_3D\_Left View\_2.17GHz

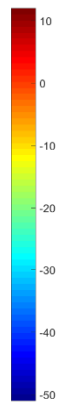
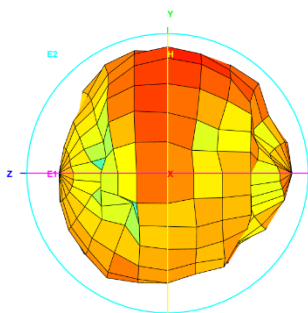

Total\_3D\_Side View 1\_2.17GHz

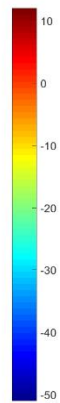
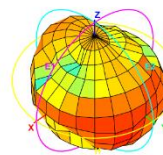



Total\_3D\_Top View\_2.4GHz

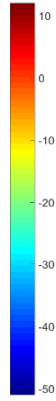
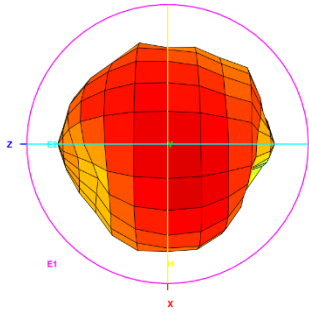

Total\_3D\_Front View\_2.4GHz

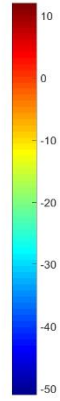
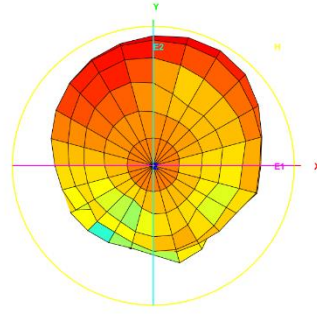

Total\_3D\_Left View\_2.4GHz

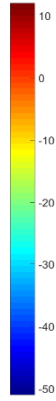
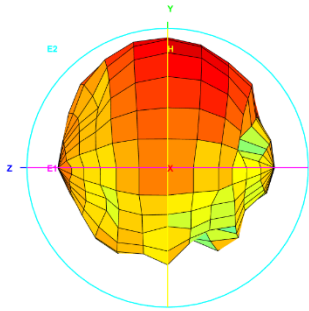

Total\_3D\_Side View 1\_2.4GHz

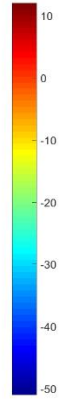
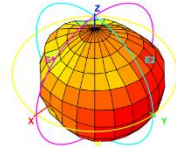

Total\_3D\_Top View\_2.5GHz

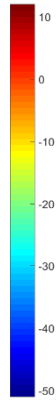
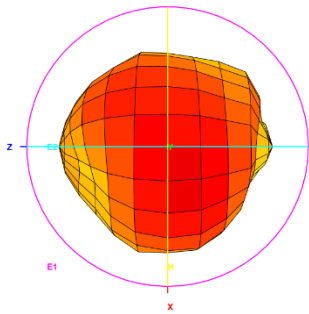

Total\_3D\_Front View\_2.5GHz

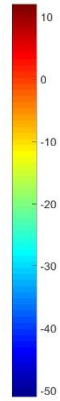
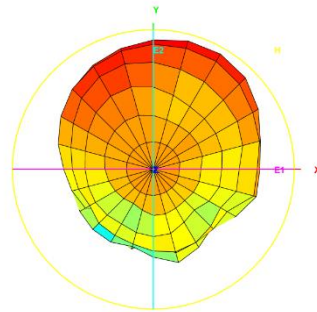

Total\_3D\_Left View\_2.5GHz

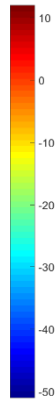
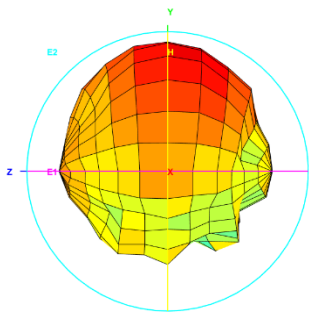

Total\_3D\_Side View 1\_2.5GHz

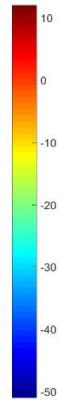
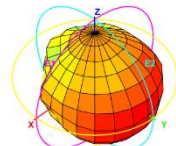

Total\_3D\_Top View\_2.6GHz

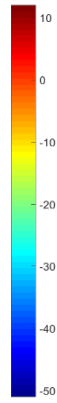
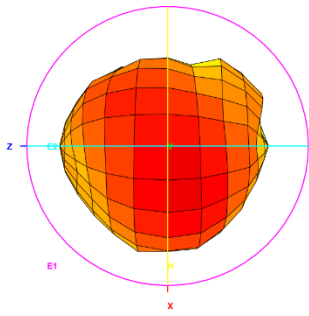

Total\_3D\_Front View\_2.6GHz

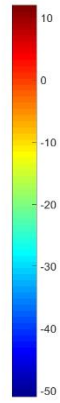
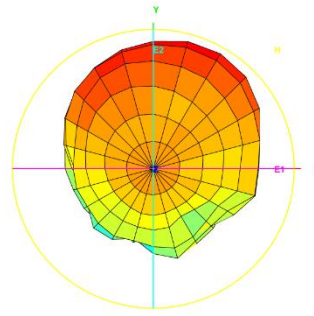

Total\_3D\_Left View\_2.6GHz

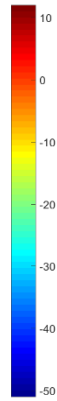
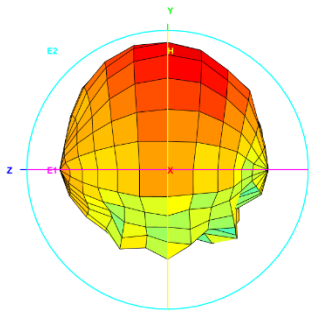

Total\_3D\_Side View 1\_2.6GHz

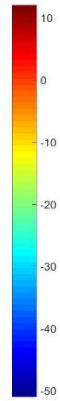
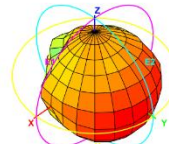

Total\_3D\_Top View\_2.7GHz

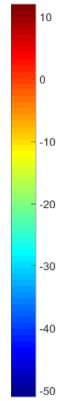
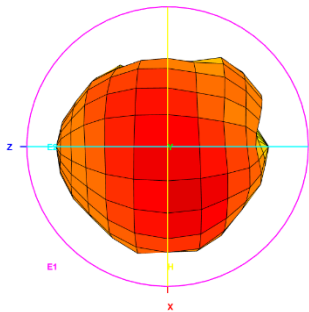

Total\_3D\_Front View\_2.7GHz

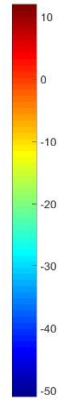
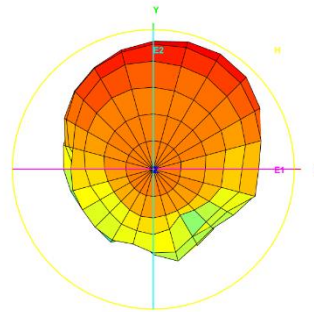

Total\_3D\_Left View\_2.7GHz

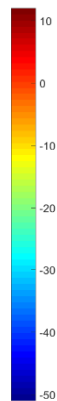
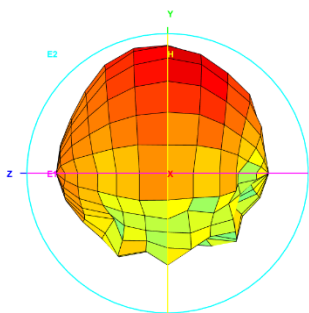

Total\_3D\_Side View 1\_2.7GHz

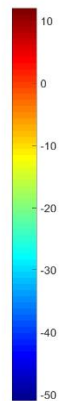
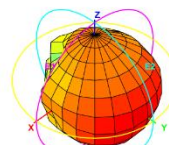

Total\_3D\_Top View\_3.3GHz

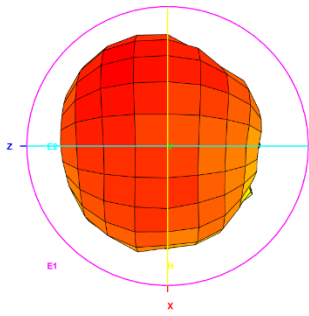

Total\_3D\_Front View\_3.3GHz

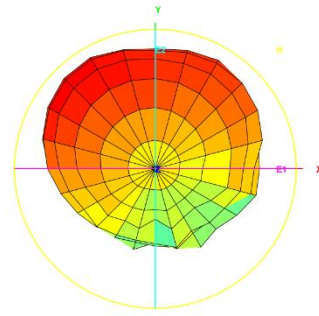

Total\_3D\_Left View\_3.3GHz

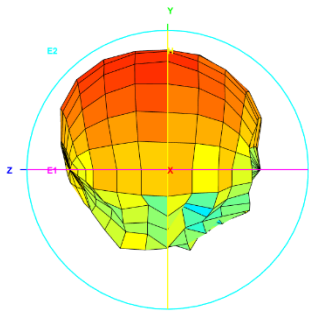

Total\_3D\_Side View 1\_3.3GHz

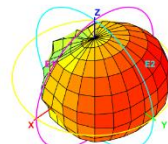

Total\_3D\_Top View\_3.6GHz

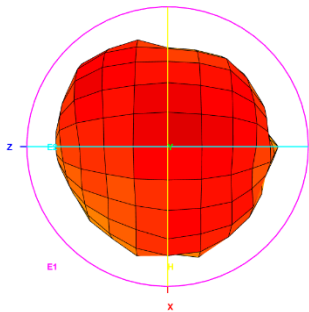

Total\_3D\_Front View\_3.6GHz

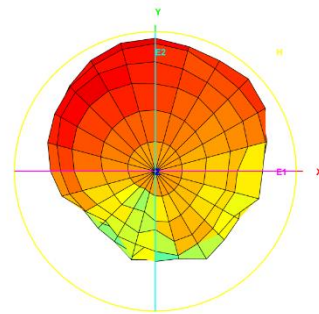

Total\_3D\_Left View\_3.6GHz

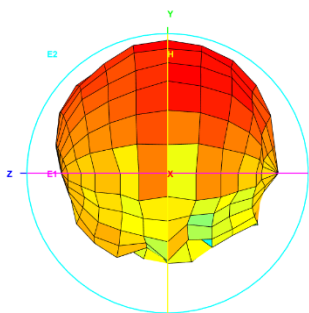

Total\_3D\_Side View 1\_3.6GHz

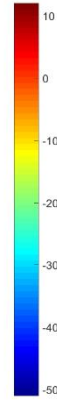
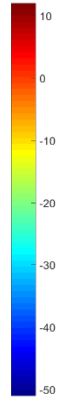
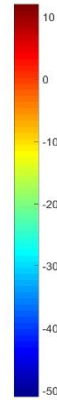
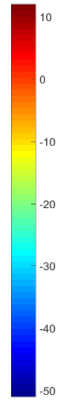
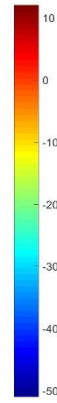
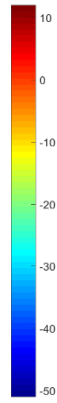
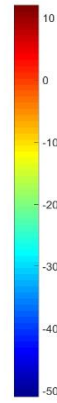
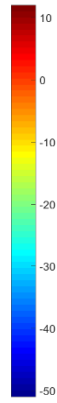
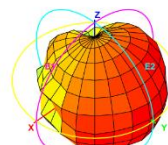

Total\_3D\_Top View\_3.8GHz

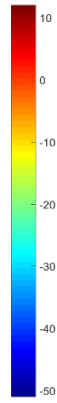
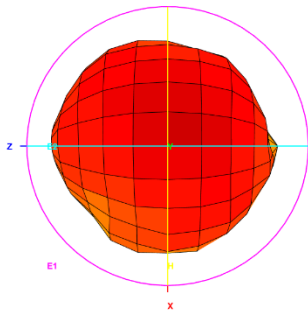

Total\_3D\_Front View\_3.8GHz

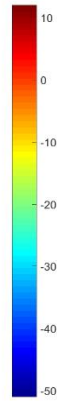
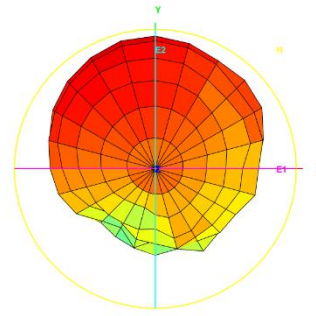

Total\_3D\_Left View\_3.8GHz

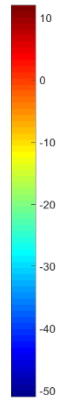
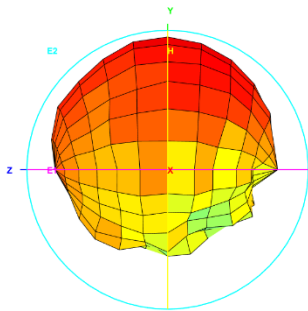

Total\_3D\_Side View 1\_3.8GHz

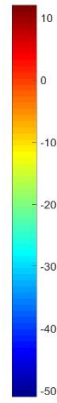
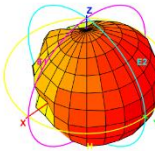

Total\_3D\_Top View\_4.4GHz

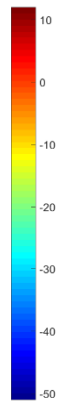
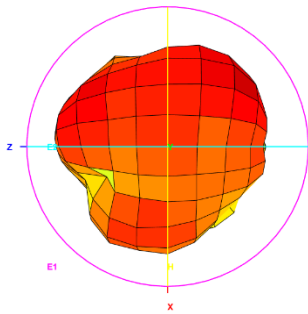

Total\_3D\_Front View\_4.4GHz

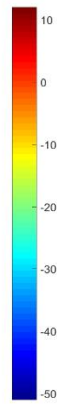
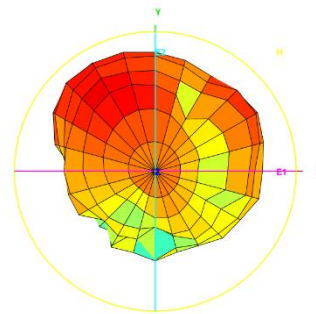

Total\_3D\_Left View\_4.4GHz

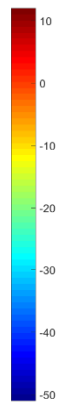
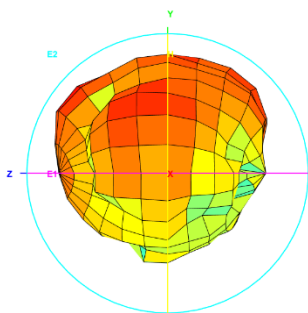

Total\_3D\_Side View 1\_4.4GHz

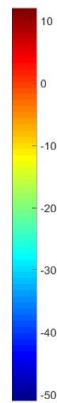
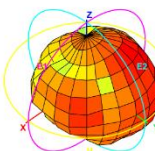

Total\_3D\_Top View\_5.15GHz

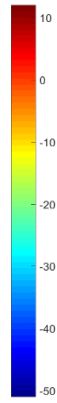
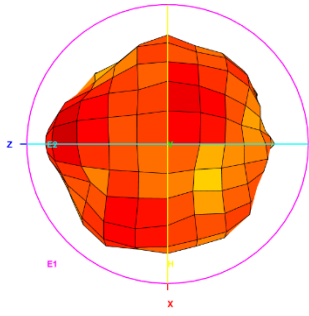

Total\_3D\_Front View\_5.15GHz

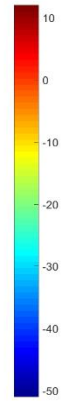
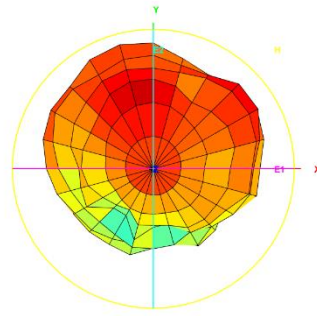

Total\_3D\_Left View\_5.15GHz

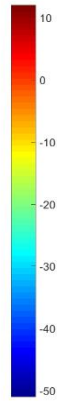
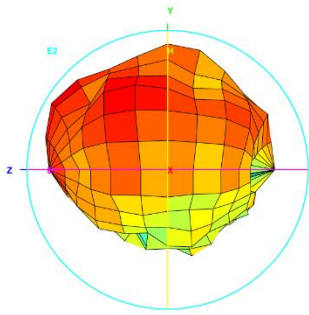

Total\_3D\_Side View 1\_5.15GHz

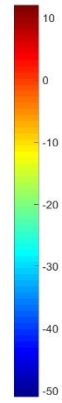
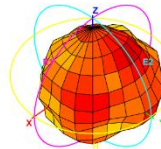

Total\_3D\_Top View\_5.5GHz

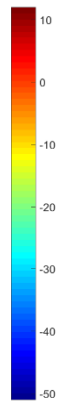
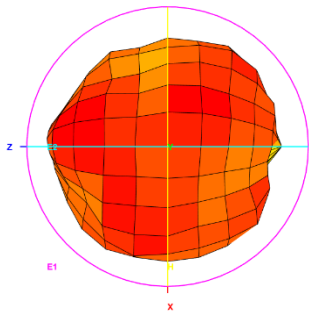

Total\_3D\_Front View\_5.5GHz

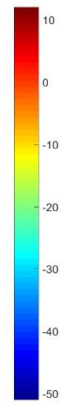
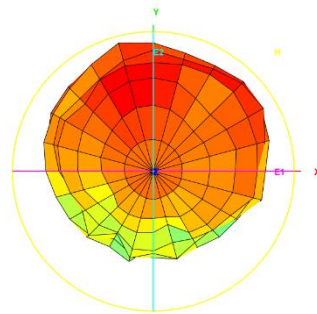

Total\_3D\_Left View\_5.5GHz

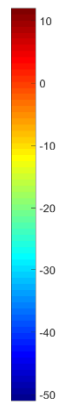
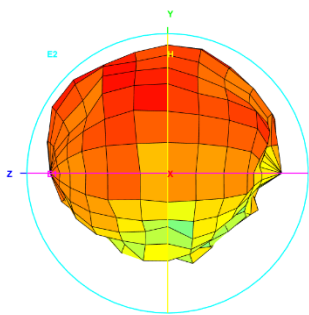

Total\_3D\_Side View 1\_5.5GHz

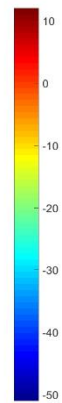
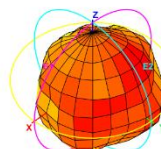

Total\_3D\_Top View\_5.8GHz

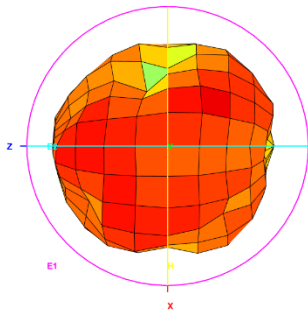

Total\_3D\_Front View\_5.8GHz

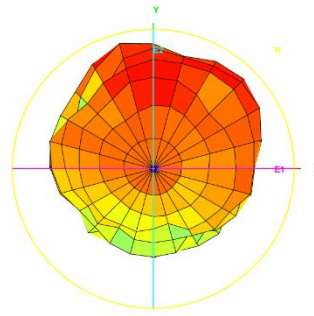

Total\_3D\_Left View\_5.8GHz

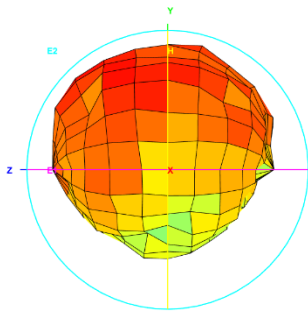

Total\_3D\_Side View 1\_5.8GHz

